

## 1/4" Square, Multi-Turn, Through-Hole Sealed Cermet Trimmers

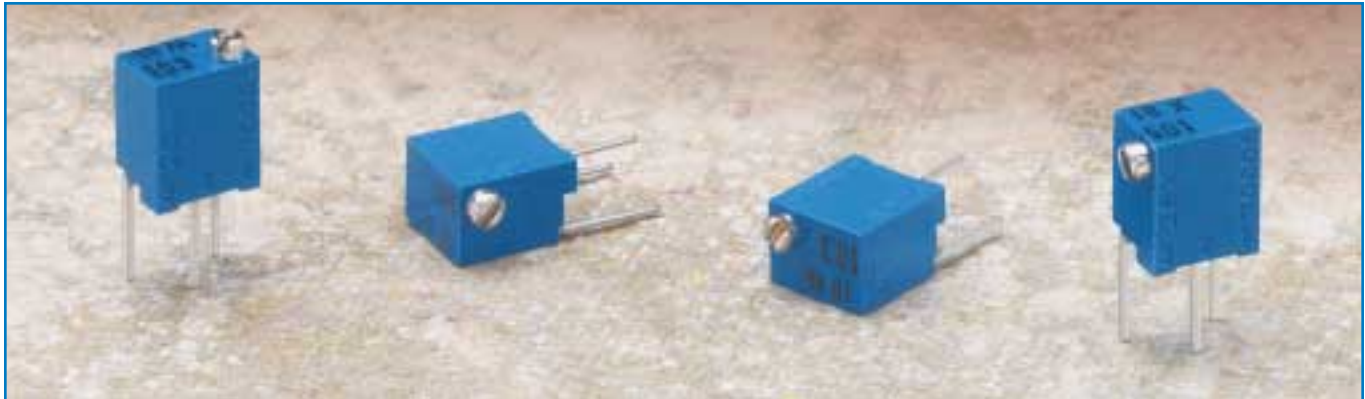

### Features

- 1/4" square, multi-turn, through-hole, sealed cermet trimmers
- 11-turn design for more accurate setting
- State-of-the-art brush contact design
- Stop-clutch action at ends of element
- Top and side adjust models
- Meets UL 94V-0 flammability requirements
- Sealed to withstand wave soldering and immersion cleaning

### Specifications

#### Electrical

<b>Standard Resistance Range</b>	100Ω to 5MΩ (standard 1, 2 & 5 sequence plus 3MΩ rating)
<b>Resistance Tolerance</b>	±10% and ±20% (up to 2MΩ) +30%, -20% (3MΩ and 5MΩ)
<b>End Resistance</b>	1% or 2Ω, whichever is greater
<b>Resistance Taper</b>	Linear
<b>Peak Noise (C.R.V.)</b>	2% or 3Ω, whichever is greater
<b>Power Rating</b>	0.25 watt at +70°C, 0 watt at +125°C
<b>Maximum Input Voltage</b>	300VDC or power rating, whichever is smaller
<b>Temperature Coefficient</b>	±100ppm/°C, 200Ω to 1MΩ ±250ppm/°C, other value
<b>Insulation Resistance</b>	1,000MΩ minimum at 500VDC
<b>Dielectric Strength</b>	600VAC, 1 minute
<b>Adjustment Travel</b>	8.5 turns ±1

#### Mechanical

<b>Mechanical Travel</b>	11 turns ±1
<b>Shaft Torque</b>	200 gf·cm (2.77 oz·in) max.
<b>Stop Strength</b>	Clutch action
<b>Flammability of Plastic Materials</b>	Meets UL 94V-0
<b>Nominal Weight</b>	0.3g
<b>Marking</b>	Resistance code, date code, model type, terminal identification

#### Environmental

<b>Temperature Range</b>	-55°C to +125°C
<b>Low Temperature Operation</b>	-55°C, 0.25 watt, 1 hour ΔT/R ≤ ±2%
<b>High Temperature Exposure</b>	+125°C, 250 hours ΔT/R ≤ ±2%, S.S. ≤ ±1%
<b>Load Life</b>	+70°C, 0.25 watt, 1,000 hours ΔT/R ≤ ±2%, S.S. ≤ ±3%
<b>Thermal Shock</b>	-55°C, +125°C, 30 minutes each, 5 cycles ΔT/R ≤ ±1%, S.S. ≤ ±1%
<b>Shock</b>	100G, 6ms, 6 directions, 3 times each ΔT/R ≤ ±1%, S.S. ≤ ±1%
<b>Vibration</b>	10-2,000Hz, 1.5mm amplitude, 20G, 12 hours ΔT/R ≤ ±1%, S.S. ≤ ±1%
<b>Humidity</b>	+40°C, 90-95% RH, 0.25 watt, 500 hours ΔT/R ≤ ±3%, S.S. ≤ ±1%
<b>Moisture Resistance</b>	-10°C to +65°C, 80-98% RH, 0.25 watt, 10 cycles, 240 hours ΔT/R ≤ ±3%
<b>Soldering Heat Resistance</b>	350°C, 3 seconds ΔT/R ≤ ±1%
<b>Seal Test</b>	+85°C, hot water for 1 minute
<b>Rotational Life</b>	200 cycles without discontinuity ΔT/R ≤ ±5%

ΔT/R = Total Resistance Change; S.S. = Setting Stability (voltage ratio)

**RJC26W**

W Terminal Style, Single-Slot, Top Adjust

**RJC26X**

X Terminal Style, Single-Slot, Side Adjust

Unit: mm

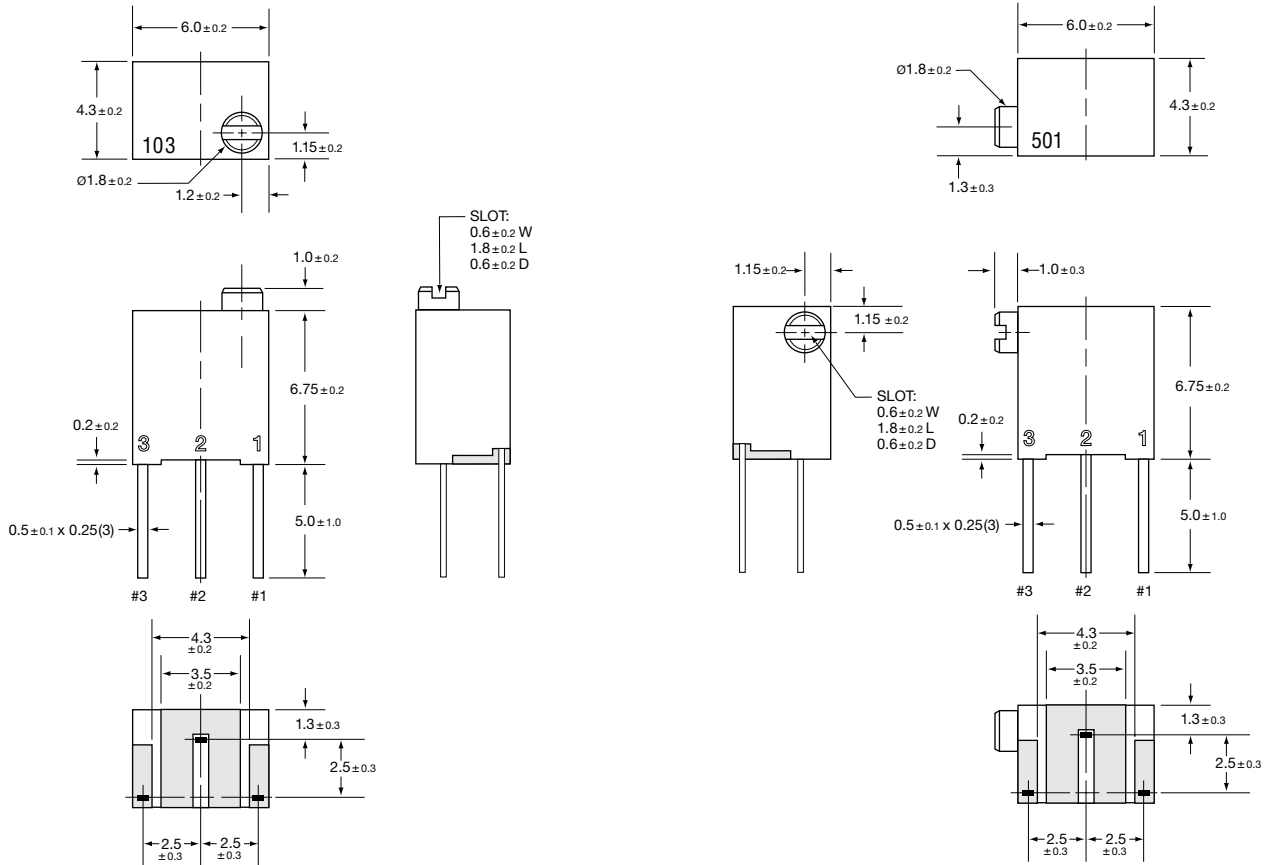

**Recommended PCB Layout**

**W & X Pin-Out**

Unit: mm

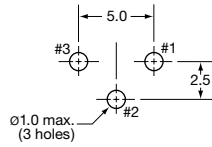

**Electrical Schematic**

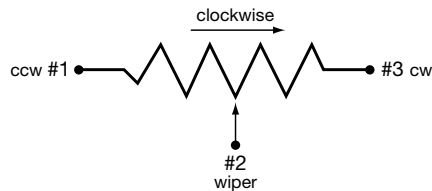

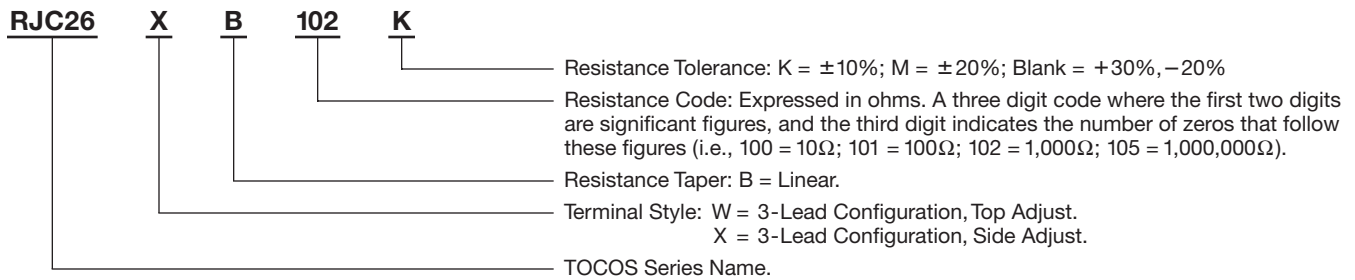



**Part Numbers**

Nominal Resistance		Catalog No. Bulk		Potentiometer Styles
Value ( $\Omega$ )	Code	Resistance Tolerance $\pm 10\%$	Resistance Tolerance $\pm 20\%$	

**RJC26W Through-Hole, W Terminal Style, Single-Slot, Top Adjust**

Value ( $\Omega$ )	Code	Resistance Tolerance $\pm 10\%$	Resistance Tolerance $\pm 20\%$	 <b>RJC26W</b>
100	101	RJC26W B 101 K	RJC26W B 101 M	
200	201	RJC26W B 201 K	RJC26W B 201 M	
500	501	RJC26W B 501 K	RJC26W B 501 M	
1,000	102	RJC26W B 102 K	RJC26W B 102 M	
2,000	202	RJC26W B 202 K	RJC26W B 202 M	
5,000	502	RJC26W B 502 K	RJC26W B 502 M	
10,000	103	RJC26W B 103 K	RJC26W B 103 M	
20,000	203	RJC26W B 203 K	RJC26W B 203 M	
50,000	503	RJC26W B 503 K	RJC26W B 503 M	
100,000	104	RJC26W B 104 K	RJC26W B 104 M	
200,000	204	RJC26W B 204 K	RJC26W B 204 M	
500,000	504	RJC26W B 504 K	RJC26W B 504 M	
1,000,000	105	RJC26W B 105 K	RJC26W B 105 M	
2,000,000	205	RJC26W B 205 K	RJC26W B 205 M	
3,000,000	305	RJC26W B 305 (+30%, -20% resistance tolerance)		
5,000,000	505	RJC26W B 505 (+30%, -20% resistance tolerance)		

**RJC26X Through-Hole, X Terminal Style, Single-Slot, Side Adjust**

Value ( $\Omega$ )	Code	Resistance Tolerance $\pm 10\%$	Resistance Tolerance $\pm 20\%$	 <b>RJC26X</b>
100	101	RJC26X B 101 K	RJC26X B 101 M	
200	201	RJC26X B 201 K	RJC26X B 201 M	
500	501	RJC26X B 501 K	RJC26X B 501 M	
1,000	102	RJC26X B 102 K	RJC26X B 102 M	
2,000	202	RJC26X B 202 K	RJC26X B 202 M	
5,000	502	RJC26X B 502 K	RJC26X B 502 M	
10,000	103	RJC26X B 103 K	RJC26X B 103 M	
20,000	203	RJC26X B 203 K	RJC26X B 203 M	
50,000	503	RJC26X B 503 K	RJC26X B 503 M	
100,000	104	RJC26X B 104 K	RJC26X B 104 M	
200,000	204	RJC26X B 204 K	RJC26X B 204 M	
500,000	504	RJC26X B 504 K	RJC26X B 504 M	
1,000,000	105	RJC26X B 105 K	RJC26X B 105 M	
2,000,000	205	RJC26X B 205 K	RJC26X B 205 M	
3,000,000	305	RJC26X B 305 (+30%, -20% resistance tolerance)		
5,000,000	505	RJC26X B 505 (+30%, -20% resistance tolerance)		

**Packaging**

**Standard:** Bulk Packaging  
**Quantity:** 50 pieces per vinyl bag.  
 500 pieces per box.

**Soldering and Cleaning Guidelines**

For soldering, cleaning and other information, refer to Guidelines and Precautions for Using Potentiometers.